

puroair

PuroAir Lite
USER MANUAL

Copyright © 2025, PuroAir
READ AND SAVE THESE INSTRUCTIONS

TABLE OF CONTENTS

Safety precautions	4
<hr/>	
Product information	7
Placement of air purifier	8
Filter installation	9
Understanding the role of filters	12
3 stage filter	13
Using the purifier	15
Turning on the purifier	16
Sleep mode and child lock	17
Filter reset	17
Maintenance and cleaning	18
Machine troubleshooting	20
Browse other products	22
Product warranty	24



SAFETY PRECAUTIONS

In order to avoid possible injury, damage to the unit, or damage to the surrounding areas, please pay attention to the following safety precautions.

If the power cord is damaged, do not attempt to repair it at home.

WARNING



Do not touch power plug with wet hands.



Before cleaning the purifier, make sure that the power supply has been disconnected.



Only 100-240V ~AC, 50/60Hz power supply should be used.

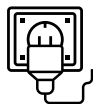

Fully plug in the air purifier before turning on.

If the plug is not fully inserted into the socket, it may cause electric shock or overheating.

Do not use damaged plugs or loose power outlets.



Do not damage the power cord and socket.

When using the purifier, do not bind the wires. Using damaged wires may lead to electric shock, short circuit or fire.

Do not cut, twist, poke and pull wires, or place heavy objects on wires or sockets.



Please clean the power plug regularly.

Pull out the power plug and clean it with a dry cloth (do not use a wet cloth).

If the appliance is not used for a long time, the power plug should be removed.

WARNING: To reduce the risk of fire, electric shock, or injury to persons, do not use replacement parts that have not been recommended by the manufacturer (e.g., parts made at home using a 3D printer).



If you need to move the product, please disconnect the power first.

Be sure to move the product slowly.

Do not move the product by pulling the power cord.

Do not move the machine while the product is in operation. If you need to move the machine, please turn off the power.



Do not use if:

If a switch does not work.

If the power cord or plug is abnormally hot.

If the fuse burns out.

If you notice a burnt odor or abnormal sound or vibration.

If there is any other abnormal phenomenon or fault.

WARNING



Do not disassemble or refit the air purifier without authorization.



Do not place rods or metal objects near or in the air outlet or opening.



Do not use benzene, thinner or other solvents to clean the air purifier.



Do not use this air purifier in a place with a high temperature, high humidity or a wet environment such as a bathroom.



Do not use the air purifier in a room with fumigation insecticides.

Chemical residues may accumulate in the unit and then be released from the air outlet which can be dangerous.

After using insecticide, the room should be thoroughly ventilated before using the air purifier.



Do not let volatile substances or combustible materials, such as tobacco and sparks, float into the purifier.

READ AND SAVE THESE INSTRUCTIONS

WARNING

To reduce the risk of fire or electric shock, do not use this appliance with any solid-state speed control devices.

Do not spray any paint, insecticide, ethyl alcohol, or any other chemical agent on the appliance's surface. It can cause a crack, electric shock, or fire. If there is a chemical accumulated inside of the device, it will be discharged from the air outlet and dispersed back into the living space. Please ensure the room is well ventilated if using any of the listed chemicals.

The air purifier should not be used in a flammable and combustible environment or environment with corrosive air.

When the device is on, please do not touch the air inlet or outlet, or put a hand or any object into the air outlet so as to prevent injury or damage to the product. Do not sit on or place any objects on the device.

Device is designed for indoor, dry location installation. Not intended for bathroom or high humidity environment. Improper usage may cause fire, electric shock, or malfunction.

Do not modify, dismantle or repair the appliance. This may cause fire, electric shock, or malfunction.

Do not use the appliance if the power cord or plug is broken, damaged, and/or defective. This can cause electric shock or fire. Do not touch the power cord with a wet hand. The power cord should only be replaced by the manufacturer or an authorized repair professional.

PRODUCT INFORMATION

PRODUCT ANATOMY

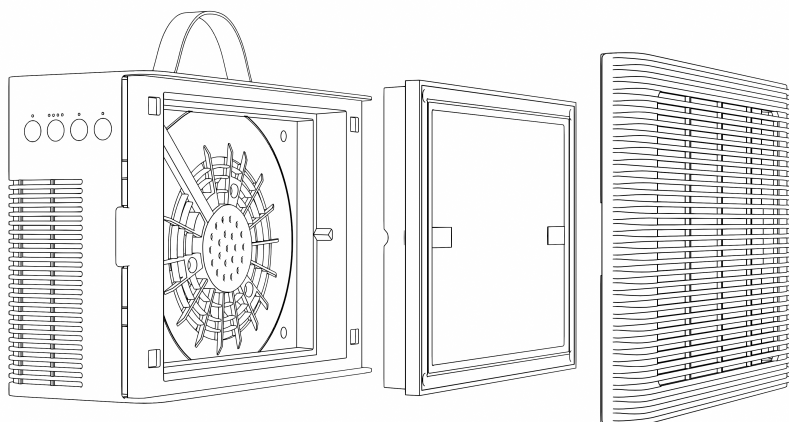
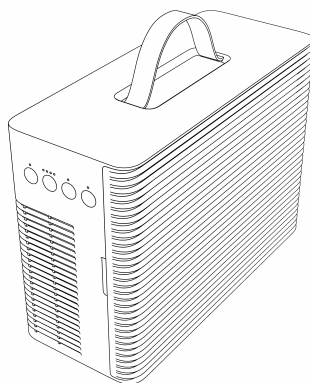
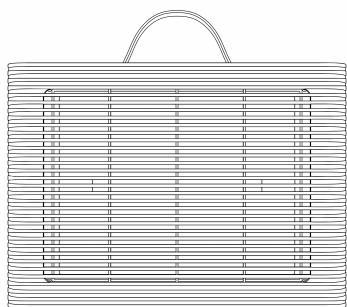

Includes power adapter. Adapter input: 100-240VAC, 50/60Hz

PLACEMENT OF AIR PURIFIER

In order to achieve optimal air circulation and filtration, make sure the air intake and output of the machine are more than 8 inches away from any obstacles.

Please keep the air purifier 3 ft away from other electrical appliances.

Do not obstruct the air intake or output to ensure adequate ventilation and maximum efficiency.

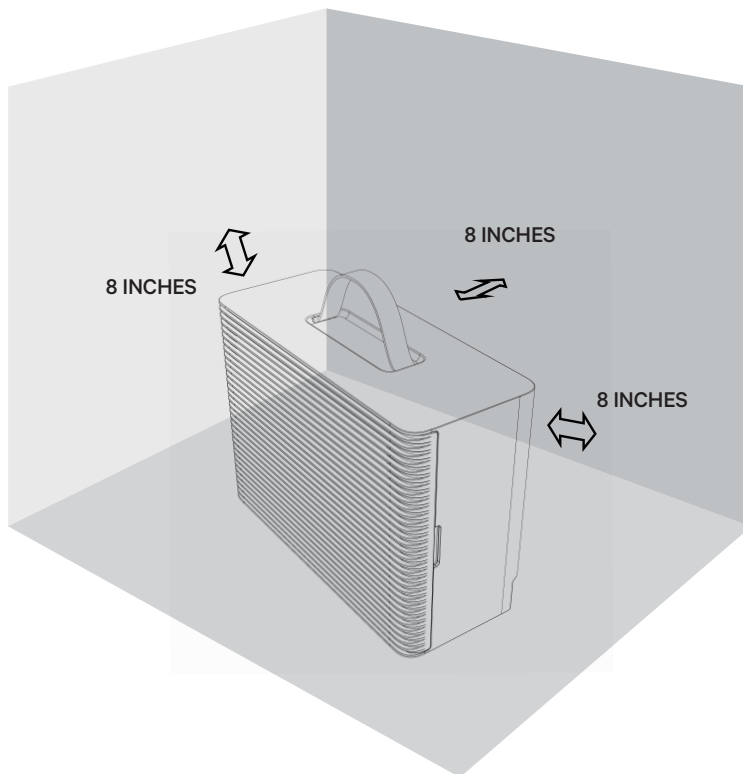

FILTER INSTALLATION

Step 1

Remove all packaging materials and place the machine on a dry, stable, level surface.

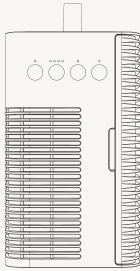

Step 2

Remove the filter cover by grabbing on both sides and pulling off.

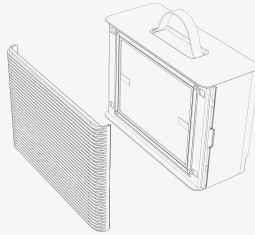

Step 3

Locate the tabs on each side of the filter and pull the filter out using the tabs.

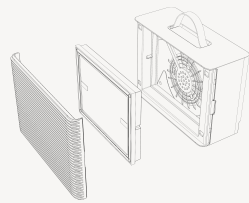

Step 4

Remove the plastic bag around the filter - don't forget this step!

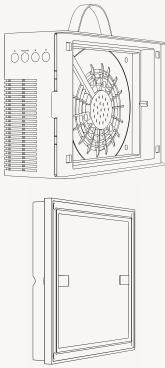

Step 5

Place the filter back inside the purifier.

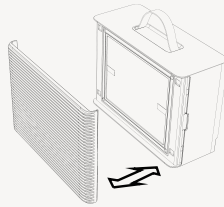

Step 6

Align the filter cover to the unit. Once the cover gets close enough to the unit, magnets will snap the cover back into place.

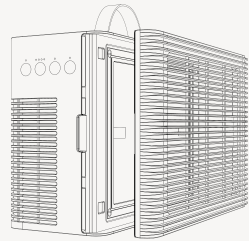

- Do not operate the purifier without a filter.
- Check to make sure the plastic bag around the filter has been removed before use.
- Only use genuine PuroAir filters with this purifier. Other filters may cause operational issues that will limit the effectiveness of the unit.



UNDERSTANDING THE ROLE OF FILTERS

Filtered air flows into your space through the air outlet on the side of the product.

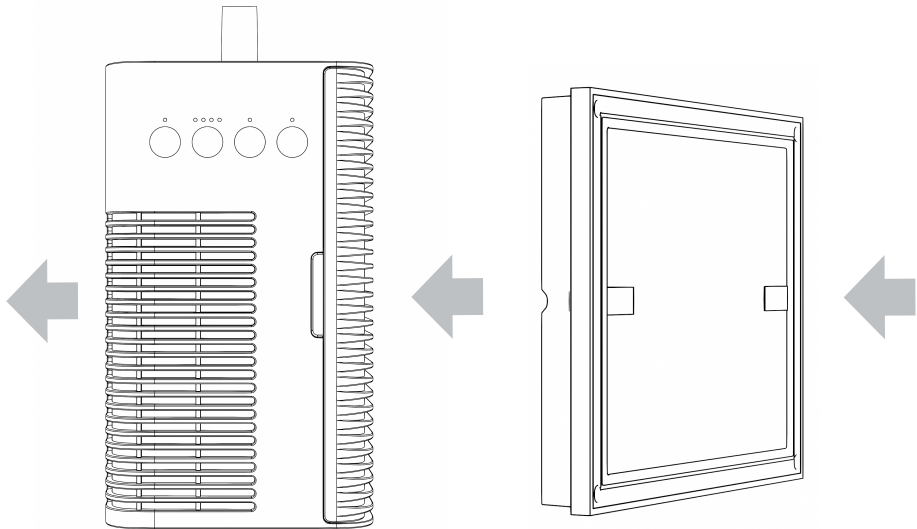

Unfiltered air is pulled into the air intake on the front of the product.

Dirty air is pulled through the filter, preventing contaminants from passing and filtered air flows through the fan and out into your space.

UNIQUE TRIPLE PURIFICATION TECHNOLOGY

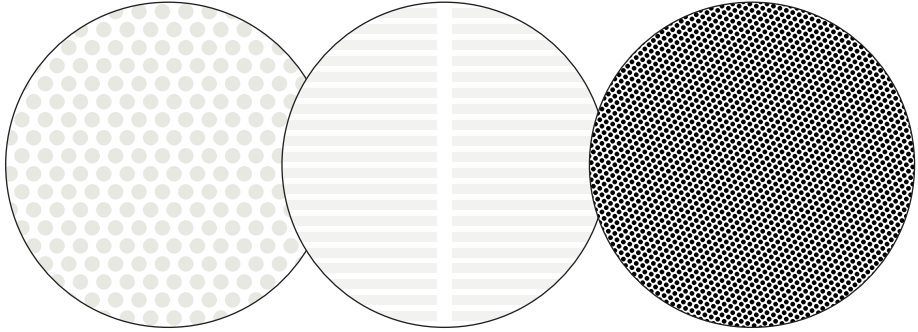

Pre-Screen
Filter



High Efficiency
HEPA Filter



CarbonTech™
Activated Carbon Filter

High efficiency HEPA & activated carbon are combined in the same filter.



USING THE PURIFIER

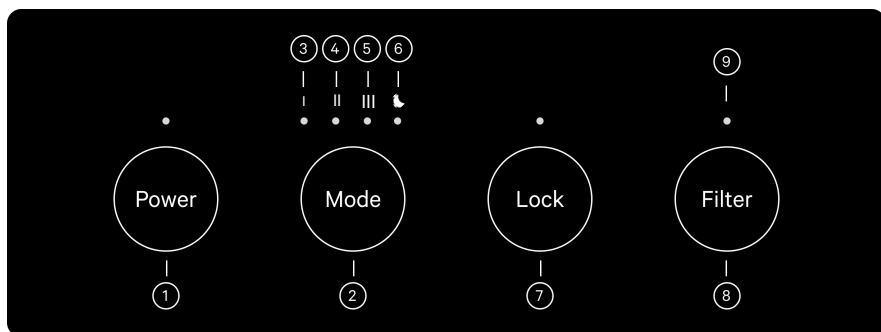

- | | | | |
|---|----------------------------|---|-------------------------|
| 1 | Power button | 6 | Sleep mode indicator |
| 2 | Mode button | 7 | Child lock button |
| 3 | Low fan speed indicator | 8 | Filter reset button |
| 4 | Medium fan speed indicator | 9 | Filter change indicator |
| 5 | High fan speed indicator | | |



FUNCTIONS IN DETAIL

Powering on or off

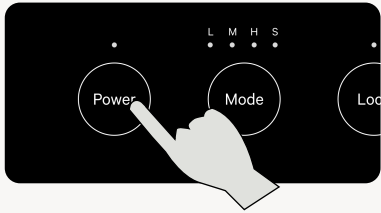

Power Button

To turn the unit on, plug it in and then press the Power button. You will hear a beep and then the unit will start running at low fan speed and the Low fan speed indicator will illuminate. To turn the unit off, press the Power button again and all LEDs will turn off.

Fan & Sleep Modes

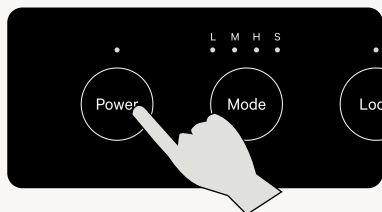

Mode Button

When first powered on, the Low fan speed indicator will illuminate to show that the unit is operating on low fan speed. Press the Mode button to cycle the fan between low, medium, high, and sleep fan speeds before cycling back to low.

Sleep Mode

When you enter the sleep mode, the sleep indicator light will dimly illuminate, all other lights will turn off, and the fan will be adjusted to a lower speed. To exit sleep mode, press any button and the sleep indicator will turn off and the unit will default to Low fan speed.

Lock & Filter Functions

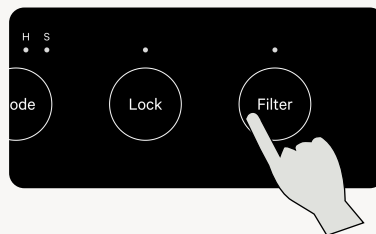

Filter Button

Your unit has a countdown to measure the useful life of your filter. When it is time to replace your filter, the Filter change indicator light will illuminate red and begin flashing. Once you replace the filter, hold down the Filter reset button for 3 seconds to reset the filter countdown.

Child Lock Button

To prevent unintended button presses while the unit is in operation, press the Child lock button. All indicator lights will illuminate and flash quickly to indicate the child lock state has been turned on. You will then see the control panel return to its' previous state but the child lock indicator will remain illuminated. To exit the child lock state, hold down the Child lock button for 3 seconds. The unit will sound a short beep and all button functions will return to normal.

MAINTENANCE & CLEANING



Unplug the power plug before cleaning the product.

Do not immerse the product in water or any other liquid.

Do not use abrasives or corrosive cleaning agents.

The filter is not washable.

Clean air purifier

Clean the inside and outside of the purifier body regularly to prevent dust accumulation.

- Use a soft dry cloth to wipe dust off the purifier.
- Clean the air intake and output with a soft dry cloth.

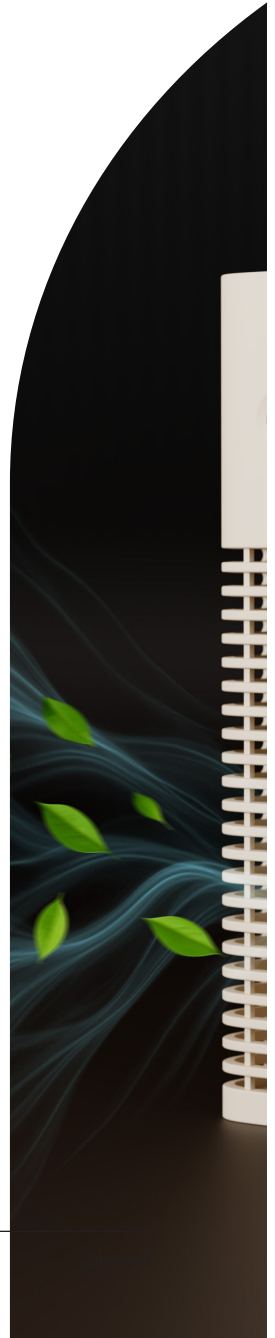



MACHINE TROUBLESHOOTING

Questions or Concerns?

Our US based team is here to help.

Email us at help@getpuroair.com or call us at +1 (866) 552-9322

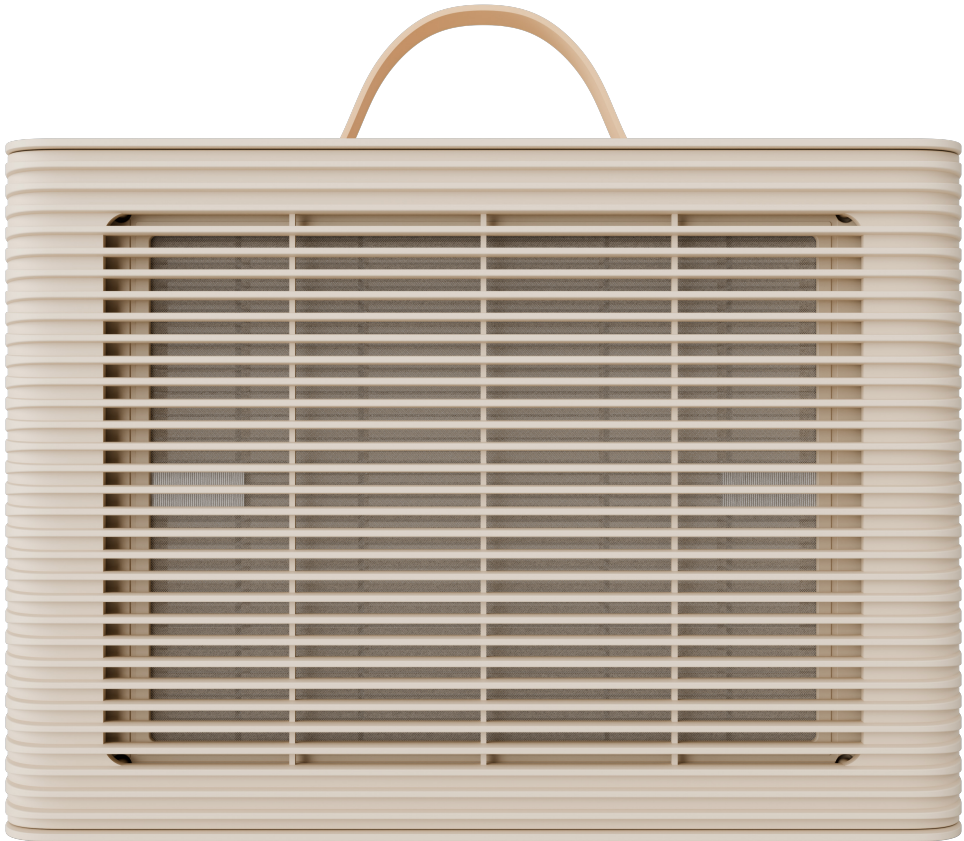

State	Possible causes	Possible solution
Machine won't turn on	The power plug is not in place	Pull out the power plug and plug in the power again. Make sure the other side of the power cable is securely plugged into the unit.
	The power plug or wire is damaged	Please contact us at help@getpuroair.com
Fan is not working	The machine is not on	Plug in the power and turn on the machine again
	The motor is damaged	Please contact us at help@getpuroair.com
	Motor loose or foreign particles inside the machine	Please contact us at help@getpuroair.com
Poor purification performance or suboptimal purification capacity	The filter was not replaced	Replace with a new filter and be sure to hold down the Filter reset button for 3 seconds to countdown the useful life of the new filter.
	The air inlet or outlet of the machine is blocked	Use a soft, dry cloth to wipe away any excess particles. If this does not work, please contact us at help@getpuroair.com
	The plastic package of the filter is not removed	Remove the plastic package of the filter screen for reuse
	There is not proper clearance or space around the machine to ventilate it	Make sure that the air inlet and outlet of the machine are not less than 8 inches away from obstacles
	There is no filter in the machine	Make sure that the filter is placed in the machine in the direction indicated. Always use a genuine PuroAir filter for optimal performance.
	More than expected room coverage	Be sure to account for ceiling height as higher ceilings will impact the coverage area a purifier would need to address.

BROWSE OUR OTHER PRODUCTS:

AIR PURIFIERS



PuroAir 130i



PuroAir 240



PuroAir 400

REPLACEMENT AIR FILTERS:



PuroAir 130i Filter



PuroAir 240 Filter



PuroAir 400 Filter



HVAC MEGA Filter

READY TO REPLACE YOUR AIR FILTER?

Purchase replacement filters through Walmart.com

Genuine PuroAir Filters

PuroAir filters are high quality performance filters designed and tested to filter pollen, dust, pet dander, smoke, odors, and more.

Cost Savings

Every filter you receive through your subscription comes with a discount, saving you money compared to one-time purchases.

Hassle-Free:

No need to remember when to reorder filters—they arrive at your doorstep just when you need them.

Flexible Management

You can skip shipments or adjust your delivery schedule anytime to fit your needs.

Order your replacement filter today:

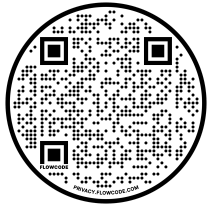

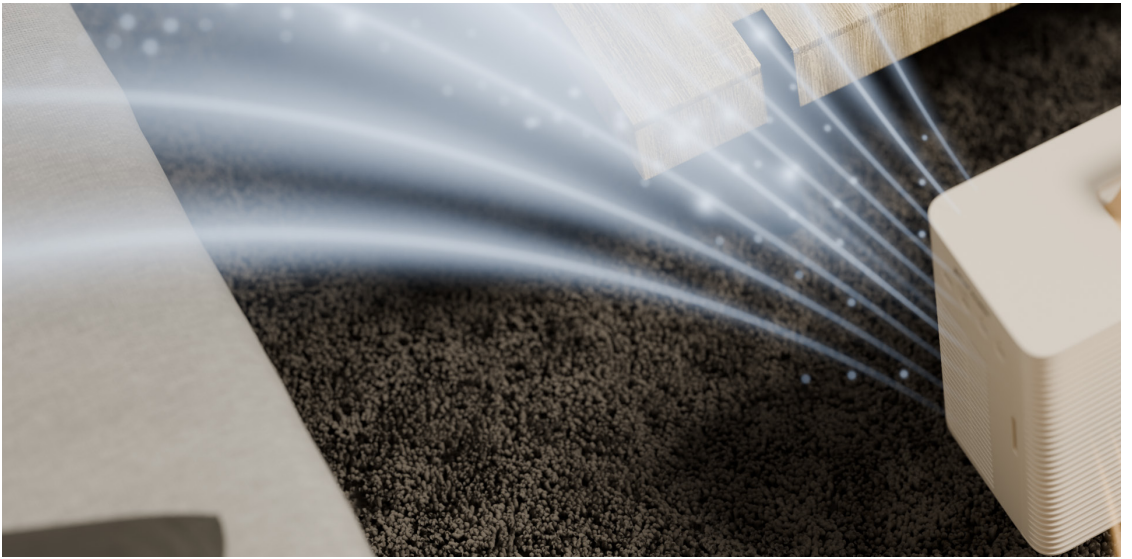

WARRANTY INFORMATION

Congratulations on your purchase of a PuroAir purifier! We stand by the quality of our products and are pleased to offer you peace of mind with our comprehensive warranty coverage.

Purifier **Limited** Warranty:

All PuroAir purifiers purchased directly from us or through our authorized resellers include a 2-year warranty. This covers any defects or issues with your device for up to two years from the date of delivery.

Register your product for faster support, helpful updates, and a smoother service experience.

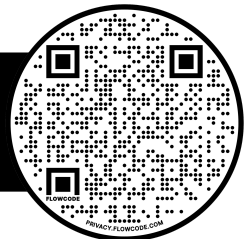

For detailed warranty information, please contact us at help@getpuroair.com.



Purifier **Lifetime** Warranty:

We go even further for our loyal customers. By maintaining an active filter subscription, your purifier is covered under our exclusive Lifetime Warranty. This means as long as your filter subscription remains active, your purifier is protected against any defects or issues.

Note: Customers may be asked to provide order details or a receipt of an active filter subscription when using Lifetime Warranty benefits.

For detailed warranty information, please contact us at help@getpuroair.com.

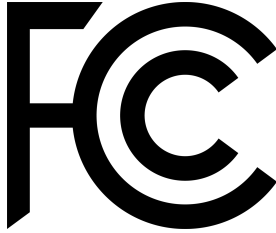

This device complies with Part 15 of the FCC Rules. Operation is subject to the following two conditions:

- (1) This device may not cause harmful interference, and
- (2) This device must accept any interference received, including interference that may cause undesired operation.

Changes or modifications not expressly approved by the party responsible for compliance could void the user's authority to operate this device.

NOTE: This equipment has been tested and found to comply with the limits for a Class B digital device, pursuant to part 15 of the FCC Rules. These limits are designed to provide reasonable protection against harmful interference in a residential installation. This equipment generates, uses, and can radiate radio frequency energy and, if not installed and used in accordance with the instructions, may cause harmful interference to radio communications. However, there is no guarantee that interference will not occur in a particular installation. If this equipment does cause harmful interference to radio or television reception, which can be determined by turning the equipment off and on, the user is encouraged to try to correct the interference by one or more of the following measures:

- Reorient or relocate the receiving antenna.
- Increase the separation between the equipment and receiver.
- Connect the equipment into an outlet on a circuit different from that to which the receiver is connected.
- Consult the dealer or an experienced radio/TV technician for help



Meets California Ozone Emissions Limit. CARB Certified.



